

ZAGZAVOD ZA
GRADBENIŠTVO
SLOVENIJESLOVENIAN
NATIONAL BUILDING
AND CIVIL ENGINEERING
INSTITUTE

Član

Member of

www.eota.eu**Dimičeva 12,
1000 Ljubljana, Slovenija**

Tel.: +386 (0)1 280 44 72, +386 (0)1-280 45 37

Fax: +386 (0)1 280 44 84

e-mail: info.ta@zag.si<http://www.zag.si>

European Technical Assessment

**ETA-10/0425
of 13.03.2024***English version prepared by ZAG*

General Part

**Technical Assessment Body issuing the
European Technical Assessment****ZAG Ljubljana****Trade name of the construction product****FM-X5****Product family to which the construction
product belongs****33: Plastic anchor for multiple use in
concrete and masonry for
non-structural applications****Manufacturer****FRIULSIDER S.p.A.
via Trieste, 1
33048 San Giovanni al Natisone (UD)
Italy
www.friulsider.com****Manufacturing plant****via Trieste, 1
33048 San Giovanni al Natisone (UD)
Italy
www.friulsider.com****This European Technical Assessment
contains****20 pages including 3 annexes, which
form an integral part of the document****This European Technical Assessment is
issued in according to Regulation (EU)
No 305/2011, on the basis of****EAD 330284-00-0604,
Edition June, 2018****This version replaces****ETA-10/0425 issued on 21.08.2019**

Translations of this European Technical Assessment in other languages shall fully correspond to the original issued document and should be identified as such.

Communication of this European Technical Assessment, including transmission by electronic means, shall be in full (excepted the confidential Annex(es) referred to above). However, partial reproduction may be made, with the written consent of the issuing Technical Assessment Body. Any partial reproduction has to be identified as such.

Specific parts

1 Technical description of the product

The FM-X5 is a plastic anchor consisting of a plastic sleeve made of polyamide and an accompanying specific screw made of carbon galvanized steel or of stainless steel.

The plastic sleeve is expanded by screwing in the specific screw which presses the sleeve against the wall of the drilled hole.

The installed anchor is shown in Annex A(1/3).

2 Specification of the intended use(s) in accordance with the applicable European Assessment Document (hereinafter EAD)

The performances given in Chapter 3 are only valid if the anchor is used in compliance with the specifications and conditions given in Annex B.

The provisions made in this European Technical Assessment are based on an assumed working life of the anchor of 50 years. The indications given on the working life cannot be interpreted as a guarantee given by the manufacturer, but are to be regarded only as a means for choosing the right products in relation to the expected economically reasonable working life of the works.

3 Performance of the product and references to the methods used for this assessment

3.2 Safety in case of fire (BWR 2)

According to the Technical Report TR 020 "Evaluation of anchorages in concrete concerning resistance to fire" it can be assumed that for fastening of facade systems the load bearing behaviour of the Plastic anchor FM-X5 ϕ 10 has a sufficient resistance to fire at least 90 minutes (R90) if the admissible load $[F_{Rk}/(\gamma_M \times \gamma_F)]$ is $\leq 0,8$ kN (no permanent centric tension load).

3.4 Safety in use (BWR 4)

The basic work requirements for safety in use are listed in Annexes C(1/12) and C(12/12).

3.8 General aspects relating to fitness for use

Durability and serviceability are only ensured if specifications of intended use according to Annex B(1/2) are kept.

4 Assessment and verification of constancy of performance (AVCP)

According to the decision 97/463/EC of the European Commission¹ the system of assessment and verification of constancy of performance (see Annex V to regulation (EU No 305/2011) 2+ apply.

¹

Official Journal of the European Communities L 198 of 25.07.1997

5 Technical details necessary for the implementation of the AVCP system, as provided in the applicable European Assessment Document

Technical details necessary for the implementation of the AVCP system are laid down in the Control plan deposited at the Slovenian National Building and Civil Engineering Institute (ZAG Ljubljana).

Issued in Ljubljana on 13.03.2024

Signed by:

Franc Capuder, M.Sc.

Head of Service of TAB

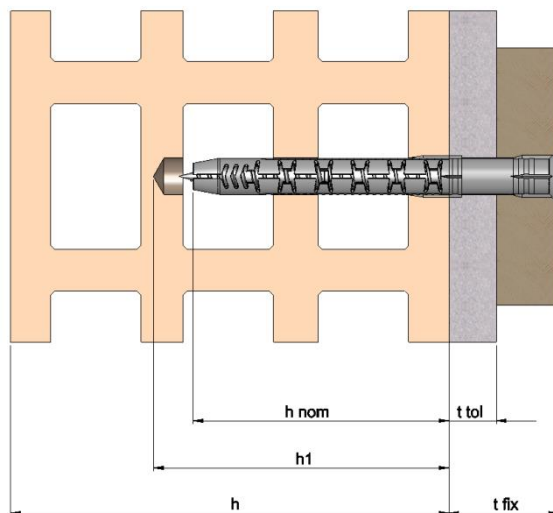
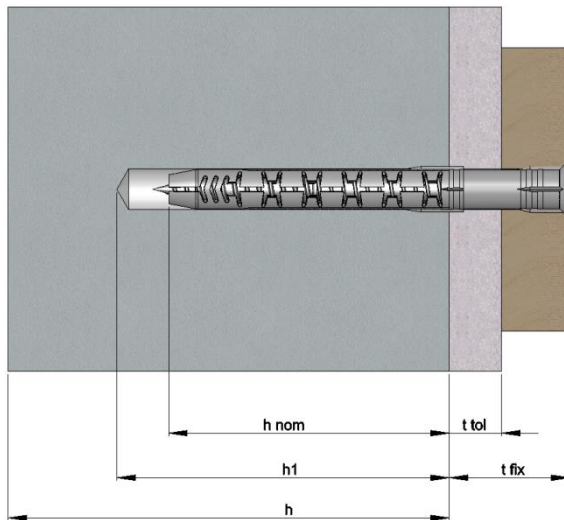

- h_1 = depth of drill hole to deepest point
- h_{nom} = overall plastic anchor embedment depth in base material
- h = thickness of member
- t_{tol} = thickness of non-structural layer
- t_{fix} = thickness of fixture

FM-X5

Product description
Installed condition

Annex A(1/3)

Plastic sleeve

Sleeve with countersunk head

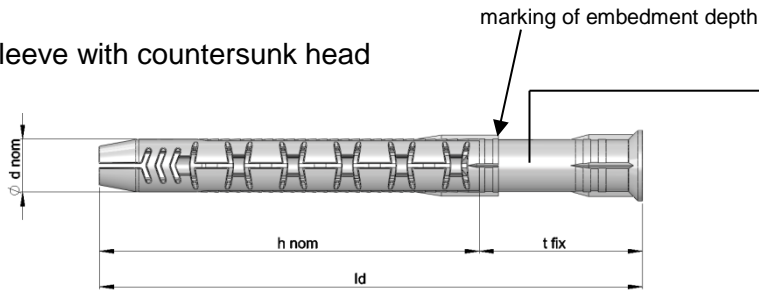

Sleeve with collar head

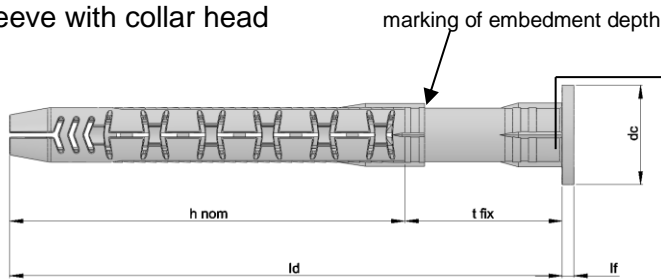

Marking:
 Identifying mark of the producer
 Anchor type
 Diameter/length
 Maximum thickness of the fixture

e.g.

X5 φ 10 × 100 ← 30 → .

Special screw

Screw with countersunk head (used for both versions of a sleeve)

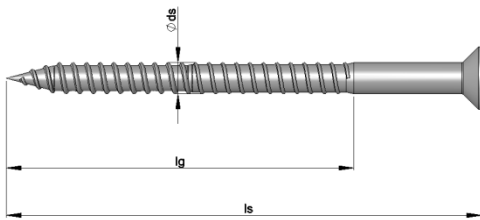

head of screw for galvanised steel and stainless steel A4



head of screw for stainless steel A4-70



Screw with hexagonal head (used for both versions of a sleeve)

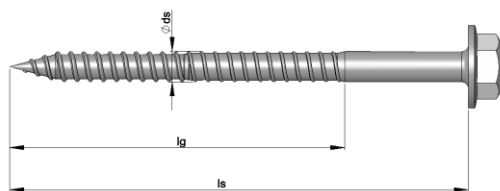

head of screw for galvanised steel and stainless steel A4



head of screw for stainless steel A4-70



FM-X5

Product description
 Anchor types

Annex A(2/3)

Table A1: Anchor dimensions

Anchor type			FM-X5 8	FM-X5 10
Overall plastic anchor embedment depth	$h_{nom} \geq$	[mm]	70	70
Plastic sleeve				
Plastic sleeve diameter	d_{nom}	[mm]	8	10
Length of plastic sleeve	l_d	[mm]	80-170	85-270
Diameter of collar head	d_c	[mm]	-	18
Thickness of collar head	l_f	[mm]	-	2,2
Thickness of fixture	t_{fix}	[mm]	1-100	1-200
Special screw				
Screw diameter	d_s	[mm]	6	7
Length of screw	l_s	[mm]	85-175	90-275
Minimum length of thread	l_g	[mm]	75	75

Table A2: Materials

Part	Material
Anchor sleeve	Polyamide PA 6 acc. To ISO 1874 - grey color
Special screw	<p>steel ϕ 7; galvanized 5μm acc. to EN ISO 4042 grey galvanic coating 10 μm acc. to EN ISO 4042; $f_{uk} \geq 600$ MPa, $f_{yk} \geq 480$ MPa stainless A4 – 1.4401 or 1.4404 or 1.4571 or 1.4578, $f_{uk} \geq 580$ MPa, $f_{yk} \geq 470$ MPa stainless A4-70 – 1.4401 or 1.4404 or 1.4571 or 1.4578, $f_{uk} \geq 700$ MPa, $f_{yk} \geq 450$ MPa</p> <p>steel ϕ 6; galvanized 5μm acc. to EN ISO 4042 grey galvanic coating 10 μm acc. to EN ISO 4042; $f_{uk} \geq 520$ MPa, $f_{yk} \geq 420$ MPa stainless A4 – 1.4401 or 1.4404 or 1.4571 or 1.4578, $f_{uk} \geq 580$ MPa, $f_{yk} \geq 470$ MPa stainless A4-70 – 1.4401 or 1.4404 or 1.4571 or 1.4578, $f_{uk} \geq 700$ MPa, $f_{yk} \geq 450$ MPa</p>

FM-X5

Product description

Dimensions and materials

Annex A(3/3)

Specifications of intended use

Anchorage subject to:

- Static and quasi static load
- Multiple fixing for non-structural applications

Base materials:

- Reinforced and non-reinforced normal weight concrete C12/15 to C50/60 (use category A) according EN 206: 2013+A1:2016;
- Solid masonry (use category B), according to Annex C(1/12) and C(3/12);
- Hollow or perforated masonry (use category C) according to Annex C(1/12), C(4/12)-C(10/12)
- Mortar strength class of the masonry has to be at least M 2,5 according to EN 998-2: 2003;
- Autoclaved Aerated Concrete (use category D) according to Annex C(1/12) and C(11/12);
- For other base materials of the use categories A, B, C and D the characteristic resistance of the anchor may be determined by job site tests according to EOTA TR 051, Edition April 2018.

Temperature range:

- a: -40°C to +40°C (max. long term temperature +24°C and max. short term temperature +40°C)
- b: -40°C to +80°C (max. long term temperature +50°C and max. short term temperature +80°C)

Use conditions (Environmental conditions):

- The specific screw made of galvanized steel may only be used in structures subject to dry internal conditions.
- The specific screw made of stainless steel may be used in structures subject to dry internal conditions and also in structures subject to external atmospheric exposure (including industrial and marine environment), or exposure in permanently damp internal conditions, if no particular aggressive conditions exist. Such particular aggressive conditions are e. g. permanent, alternating immersion in seawater or the splash zone of seawater, chloride atmosphere of indoor swimming pools or atmosphere with extreme chemical pollution (e. g. in desulphurization plants or road tunnels where de-icing materials are used).

Design:

- The design of anchorages is carried out in compliance with Technical Report TR 064:2018-05, under the responsibility of an engineer experienced in anchorages
- Verifiable calculation notes and drawings shall be prepared taking account of the loads to be anchored, the nature and strength of the base materials and the dimensions of the anchorage members as well as of the relevant tolerances.

Installation:

- Anchor installation carried out by appropriately qualified personnel under the supervision of the person responsible for technical matters on site.
- Anchor installation in accordance with the manufacturer's specifications and drawings using the tools indicated in this European Technical Approval
- Drilling method according Annex C(3/12) to C(11/12) for use category A, B, C and D.
- Temperature during installation of the anchor ≥ -20 °C (plastic sleeve and base material)
- Checks before placing the anchor, to ensure that the characteristic values of the base material in which the anchor is to be placed, is identical with the values, which the characteristic loads apply for.
- Placing drill holes without damaging the reinforcement.
- Holes to be cleaned of drilling dust.
- In case of aborted hole: New drilling at a minimum distance away of twice the depth of the aborted hole or smaller distance if the aborted drill hole is filled with high strength mortar.
- The plastic sleeve is inserted through the fixture by slight hammer blows and the special screw is screwed in until the head of the screw touches the sleeve. The anchor is correct mounted, if there is no turn-through of the plastic sleeve in the drill hole and if slightly move on turning of the screw is impossible after the complete turn-in of the screw.

FM-X5

Intended use
Specification

Annex B(1/2)

Table B1: Installation parameters

Anchor type			FM-X5 8	FM-X5 10
Drill hole diameter	$d_0 =$	[mm]	8	10
Cutting diameter of drill bit	$d_{cut} \leq$	[mm]	8,45	10,45
Depth of frill hole to deepest point	$h_1 \geq$	[mm]	80	80
Overall plastic anchor embedment depth ¹⁾	h_{nom}	[mm]	70	70
Diameter of clearance hole in the fixture	d_f	[mm]	8,5	10,5

¹⁾ See Annex A(1/1)

Table B2: Minimum thickness of member, edge distance and anchor spacing in concrete

FM-X5			Concrete C12/15	Concrete $\geq 16/20$
Minimum thickness of member	h_{min}	[mm]	100	100
Minimum spacing and edge distance	C_{min}	[mm]	80	60
	S_{min}	[mm]	80	60
Characteristic edge distance	$C_{cr,N}$	[mm]	140	100

Table B3: Minimum thickness of member, edge distance and anchor spacing in masonry

FM-X5			Masonry	
Minimum thickness of member	h_{min}	[mm]	106 ²⁾	
Single anchor				
Minimum spacing	S_{min}	[mm]	250	
Minimum edge distance	C_{min}	[mm]	100	
Anchor group				
Spacing perpendicular to free edge	$S1_{min}$	[mm]	200	
Spacing parallel to free edge	$S2_{min}$	[mm]	400	
Minimum edge distance	C_{min}	[mm]	100	

²⁾ See Annexes C(3/12) to C(10/12)

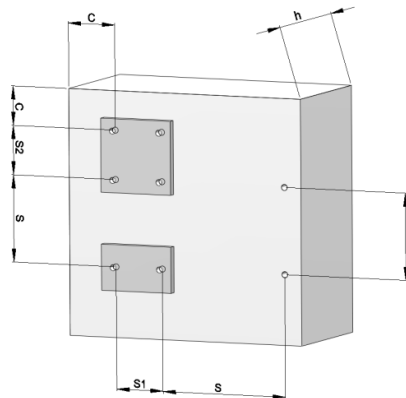

FM-X5

Intended use

Installation parameters, minimum thickness, edge distance and spacing

Annex B(2/2)

Table C1: Base material

Base material	Dimensions L×B×H [mm]	Minimum compressive strength [MPa]	Bulk density class [kg/dm ³]	Annex
Concrete				
Concrete ≥ C12/15	EN 206			Annex C(2/12)
Solid masonry				
Solid brick acc. to EN 771-1	251×120×55	43,77	≥ 1,8	Annex C(3/12)
Hollow or perforated masonry				
Hollow clay brick – bimattone acc. to EN 771-1	250×120×120	27,30	≥ 1,0	Annex C(4/12)
Hollow clay brick – alveolater svizzero pesante acc. to EN 771-1	300×250×190	13,83	≥ 0,9	Annex C(5/12)
Hollow clay brick – alveolater incastro 35 acc.to EN 771-1	350×240×245	10,93	≥ 0,8	Annex C(6 /12)
Hollow clay brick – blocco leggero acc. to EN 771-1	250×120 500	7	≥ 0,5	Annex C(7/12)
Hollow clay brick – poroton acc.to EN 771-1	250×300×190	22	≥ 0,9	Annex C(8/12)
Hollow clay brick – BP category 1 – HD acc.to EN 771-1	224×106×54	30	≥ 1,3	Annex C(9/12)
Hollow brick light weight concrete BC 203 n°26 acc.to EN 771-3	490×200×190	4	≥ 0,95	Annex C(10/12)
Autoclaved Aerated Concrete – AAC gasbeton evolution 500	625×250×200	2,5	≥ 0,50	Annex C(11/12)

Table C2: Characteristic bending resistance of the special screw in concrete, masonry and Autoclaved Aerated Concrete

		Galvanized steel		Stainless steel A4		Stainless steel A4-70	
		FM-X5 8	FM-X5 10	FM-X5 8	FM-X5 10	FM-X5 8	FM-X5 10
Characteristic bending resistance	$M_{Rk,s}$ [Nm]	8,61	16,84	9,60	21,95	13,57	24,78
Partial safety factor	γ_{Ms} ¹⁾	1,23	1,25	1,25	1,25	1,56	1,56

¹⁾ In absence of other national regulations

FM-X5	Annex C(1/12)
Performance Base material, characteristic bending resistance of the screw	

Table C3: Characteristic resistance for use in concrete

Anchor type			FM-X5 8			FM-X5 10		
			Galvan. steel	Stainless steel		Galvan. steel	Stainless steel	
Steel failure (special screw)				A4	A4-70		A4	A4-70
Characteristic tension resistance	$N_{Rk,s}$	[kN]	11,0	12,3	16,5	18,1	21,2	25,0
Partial safety factor	$\gamma_{Ms}^{1)}$	[-]	1,48	1,48	1,88	1,50	1,48	1,88
Characteristic shear resistance	$V_{Rk,s}$	[kN]	5,52	6,16	8,25	9,05	10,60	12,5
Partial safety factor	$\gamma_{Ms}^{1)}$	[-]	1,23	1,23	1,56	1,25	1,25	1,56
Pull-out failure (plastic sleeve)								
Concrete \geq C16/20								
Characteristic resistance	$24^{\circ}C^{2)}/40^{\circ}C^{3)}$	$N_{Rk,p}$	[kN]	2,5		3,5		
	$50^{\circ}C^{2)}/80^{\circ}C^{3)}$	$N_{Rk,p}$	[kN]	1,2		2,5		
Partial safety factor	$\gamma_{Mc}^{1)}$	[-]	1,8					
Concrete C12/15								
Characteristic resistance	$24^{\circ}C^{2)}/40^{\circ}C^{3)}$	$N_{Rk,p}$	[kN]	1,5		2,5		
	$50^{\circ}C^{2)}/80^{\circ}C^{3)}$	$N_{Rk,p}$	[kN]	0,75		1,5		
Partial safety factor	$\gamma_{Mc}^{1)}$	[-]	1,8					
Concrete cone failure and concrete edge failure for single anchor and anchor group								
Tension load ⁴⁾								
$N_{Rk,c} = 7,2 \cdot \sqrt{f_{ck,cube}} \cdot h_{ef}^{1,5} \cdot \frac{c}{c_{cr,N}} = N_{Rk,p} \cdot \frac{c}{c_{cr,N}}$			with: $h_{ef}^{1,5} = \frac{N_{Rk,p}}{7,2 \cdot \sqrt{f_{ck,cube}}}$					
			$\frac{c}{c_{cr,N}} \leq 1$					
Shear load ⁴⁾								
$V_{Rk,c} = 0,45 \sqrt{d_{nom}} \cdot \left(\frac{h_{nom}}{d_{nom}}\right)^{0,2} \cdot \sqrt{f_{ck,cube}} \times c_1^{1,5} \times 0,5 \times \sqrt{\frac{c_2}{1,5c_1}} \cdot \sqrt{\frac{h}{1,5c_1}}$			with: $\sqrt{\frac{c_2}{1,5c_1}} \leq 1$					
			$\sqrt{\frac{h}{1,5c_1}} \leq 1$					
c_1 edge distance closest to the edge in loading direction c_2 edge distance perpendicular to direction 1 $f_{ck,cube}$ nominal characteristic concrete compression strength (based on cubes), values for C50/60 at maximum								
Partial safety factor	$\gamma_{Mc}^{1)}$	[-]	1,8					

¹⁾ In absence of other national regulations

²⁾ Maximum long term temperature

³⁾ Maximum short term temperature

⁴⁾ The design method according Technical Report TR 064:064:2018-05 is to be used

FM-X5	Annex C(2/12)
Performance Characteristic resistance in concrete (use category A)	

Base material solid masonry: Solid brick

Table C4: Brick data

Description of brick		
Type of brick		Solid brick
Bulk density	$\rho \geq$ [kg/dm ³]	1,8
Standard		EN 771-1
Format (measurement)	[mm]	$\geq 250/120/55$
Minimum thickness of member	h_{min} [mm]	120

Table C5: Installation parameters

Anchor size		FM-X5 8	FM-X5 10
Drill hole diameter	$d_0 =$ [mm]	8	10
Cutting diameter of drill bit	$d_{cut} \leq$ [mm]	8,45	10,45
Depth of drill hole to deepest point	$h_1 \geq$ [mm]	80	
Drill method	[-]	Hammer drilling	
Overall plastic embedment depth	$h_{nom} =$ [mm]	70	
Diameter of clearance hole in the fixture	d_f [mm]	8,5	10,5

Table C6: Characteristic resistance F_{Rk} ¹⁾ for single anchor

Anchor size		FM-X5 8	FM-X5 10
Solid clay brick $f_b \geq 43,77$ MPa	$24^\circ\text{C}^3/40^\circ\text{C}^4$ [kN]	3,5	3,5
Characteristic resistance F_{Rk}	$50^\circ\text{C}^3/80^\circ\text{C}^4$ [kN]	2,0	2,5
Partial safety factor	γ_{Mm} ²⁾ [-]	2,5	

¹⁾ Characteristic resistance F_{Rk} for tension, shear or combined tension and shear loading. The characteristic resistance is valid for single plastic anchor or for group of two or four plastic anchors with a spacing equal or larger than the minimum spacing s_{min} according to Table B3. The specific conditions for the design method have to be considered according to Annex B(1/2).

²⁾ In absence of other national regulations

³⁾ Maximum long term temperature

⁴⁾ Maximum short term temperature

FM-X5

Performance

Characteristic resistance in solid brick
(use category B)

Annex C(3/12)

Base material hollow masonry: Hollow clay brick - Bimattone

Table C7: Brick data

Description of brick		
Type of brick		Hollow clay brick -Bimattone
Bulk density	$\rho \geq$	[kg/dm ³] 0,9
Standard		EN 771-1
Producer of brick		Fornaci Giuliane S.p.a 34071 Cormons (Go) Italy
Format (measurement)		[mm] $\geq 250/120/120$
Minimum thickness of member	h_{min}	[mm] 120

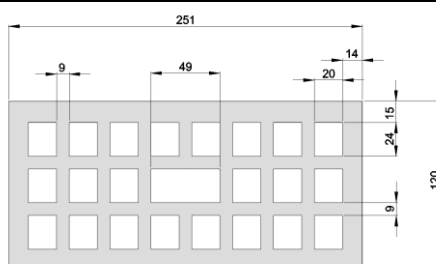

Table C8: Installation parameters

Anchor size		FM-X5 8	FM-X5 10
Drill hole diameter	$d_0 =$	[mm] 8	10
Cutting diameter of drill bit	$d_{cut} \leq$	[mm] 8,45	10,45
Depth of drill hole to deepest point	$h_1 \geq$	[mm] 80	
Drill method		[-] Rotary drilling	
Overall plastic embedment depth	$h_{nom} =$	[mm] 70	
Diameter of clearance hole in the fixture	d_f	[mm] 8,5	10,5

Table C9: Characteristic resistance F_{Rk} ¹⁾ for single anchor

Anchor size		FM-X5 8	FM-X5 10
Hollow brick - Bimattone $f_b \geq 27,3$ MPa	$24^\circ\text{C}^3/40^\circ\text{C}^4$	[kN] 1,5	1,5
Characteristic resistance F_{Rk}	$50^\circ\text{C}^3/80^\circ\text{C}^4$	[kN] 0,9	1,2
Partial safety factor	γ_{Mm} ²⁾	[-] 2,5	

¹⁾ Characteristic resistance F_{Rk} for tension, shear or combined tension and shear loading. The characteristic resistance is valid for single plastic anchor or for group of two or four plastic anchors with a spacing equal or larger than the minimum spacing s_{min} according to Table B3. The specific conditions for the design method have to be considered according to Annex B(1/2).

²⁾ IN absence of other national regulations

³⁾ Maximum long term temperature

⁴⁾ Maximum short term temperature

FM-X5	Annex C(4/12)
Performance Characteristic resistance in hollow clay brick - Bimattone (use category C)	

Base material hollow masonry: Hollow clay brick - Alveolater svizzero pesante

Table C10: Brick data

Description of brick		
Type of brick		Hollow clay brick Alveolater svizzero pesante
Bulk density	$\rho \geq$	[kg/dm ³] 0,9
Standard		EN 771-1
Producer of brick		Fornaci Giuliane S.p.a 34071 Cormons (Go) Italy
Format (measurement)		[mm] $\geq 300/250/190$
Minimum thickness of member	h_{min}	[mm] 250

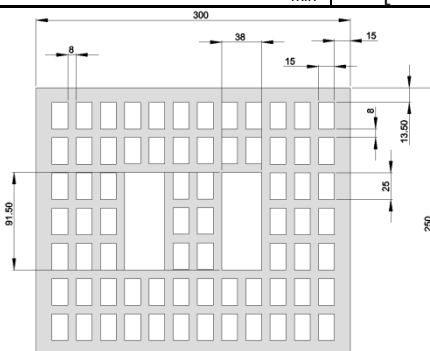

Table C11: Installation parameters

Anchor size		FM-X5 8	FM-X5 10
Drill hole diameter	$d_0 =$	[mm] 8	10
Cutting diameter of drill bit	$d_{cut} \leq$	[mm] 8,45	10,45
Depth of drill hole to deepest point	$h_1 \geq$	[mm] 80	
Drill method		[-] Rotary drilling	
Overall plastic embedment depth	$h_{nom} =$	[mm] 70	
Diameter of clearance hole in the fixture	d_f	[mm] 8,5	10,5

Table C12: Characteristic resistance F_{Rk} ¹⁾ for single anchor

Anchor size		FM-X5 8	FM-X5 10
Hollow brick - Alveolater svizzero pesante $f_b \geq 13,83$ MPa	$24^\circ\text{C}^{3)/40^\circ\text{C}^{4)}$	[kN] 1,5	1,5
	$50^\circ\text{C}^{3)/80^\circ\text{C}^{4)}$	[kN] 0,6	1,2
Characteristic resistance F_{Rk}			
Partial safety factor	γ_{Mm} ²⁾	[-] 2,5	

¹⁾ Characteristic resistance F_{Rk} for tension, shear or combined tension and shear loading. The characteristic resistance is valid for single plastic anchor or for group of two or four plastic anchors with a spacing equal or larger than the minimum spacing s_{min} according to Table B3. The specific conditions for the design method have to be considered according to Annex B(1/2).

²⁾ IN absence of other national regulations

³⁾ Maximum long term temperature

⁴⁾ Maximum short term temperature

FM-X5

Performance

Characteristic resistance in hollow clay brick -
Alveolater svizzero pesante
(use category C)

Annex C(5/12)

Base material hollow masonry: Hollow clay brick - Alveolater incastro 35

Table C13: Brick data

Description of brick		
Type of brick		Hollow clay brick Alveolater incastro 35
Bulk density	$\rho \geq$	[kg/dm ³] 0,8
Standard		EN 771-1
Producer of brick		Fornaci Giuliane S.p.a 34071 Cormons (Go) Italy
Format (measurement)		[mm] $\geq 350/240/245$
Minimum thickness of member	h_{min}	[mm] 350

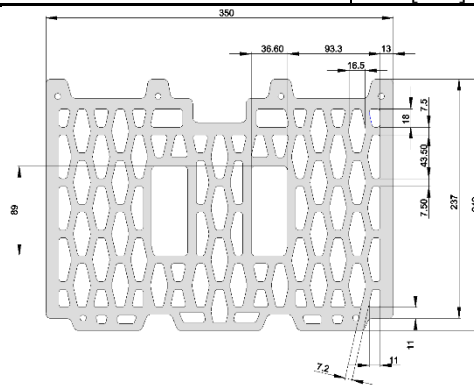

Table C14: Installation parameters

Anchor size		FM-X5 8	FM-X5 10
Drill hole diameter	$d_0 =$	[mm] 8	10
Cutting diameter of drill bit	$d_{cut} \leq$	[mm] 8,45	10,45
Depth of drill hole to deepest point	$h_1 \geq$	[mm] 80	
Drill method		[-] Rotary drilling	
Overall plastic embedment depth	$h_{nom} =$	[mm] 70	
Diameter of clearance hole in the fixture	d_f	[mm] 8,5	10,5

Table C15: Characteristic resistance F_{Rk} ¹⁾ for single anchor

Anchor size		FM-X5 8	FM-X5 10
Hollow brick - Alveolater incastro 35	$24^\circ\text{C}^3/40^\circ\text{C}^4$	[kN] 1,5	1,5
$f_b \geq 10,93 \text{ MPa}$	$50^\circ\text{C}^3/80^\circ\text{C}^4$	[kN] 0,75	1,2
Characteristic resistance F_{Rk}			
Partial safety factor	γ_{Mm} ²⁾	[-] 2,5	

¹⁾ Characteristic resistance F_{Rk} for tension, shear or combined tension and shear loading. The characteristic resistance is valid for single plastic anchor or for group of two or four plastic anchors with a spacing equal or larger than the minimum spacing s_{min} according to Table B3. The specific conditions for the design method have to be considered according to chapter Annex B(1/2).

²⁾ IN absence of other national regulations

³⁾ Maximum long term temperature

⁴⁾ Maximum short term temperature

FM-X5

Performance

Characteristic resistance in hollow clay brick -
Alveolater incastro 35
(use category C)

Annex C(6/12)

Base material hollow masonry: Hollow clay brick - Blocco leggero

Table C16 Brick data

Description of brick		
Type of brick		Hollow clay brick Blocco leggero
Bulk density	$\rho \geq$	[kg/dm ³] 0,5
Standard		EN 771-1
Producer of brick		Wienerberger Brunori SRL Burbano di Modano (Bo) Italy
Format (measurement)		[mm] $\geq 250/120/500$
Minimum thickness of member	h_{min}	[mm] 120

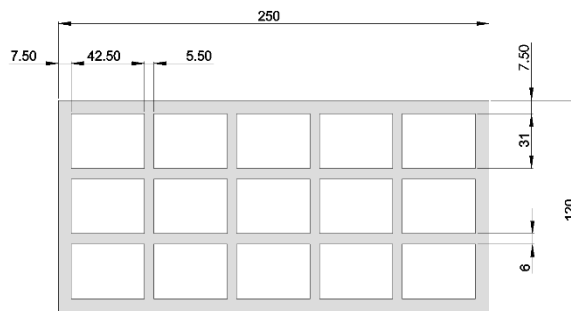

Table C17: Installation parameters

Anchor size		FM-X5 8	FM-X5 10
Drill hole diameter	$d_0 =$	[mm] 8	10
Cutting diameter of drill bit	$d_{cut} \leq$	[mm] 8,45	10,45
Depth of drill hole to deepest point	$h_1 \geq$	[mm] 80	
Drill method		[-] Rotary drilling	
Overall plastic embedment depth	$h_{nom} =$	[mm] 70	
Diameter of clearance hole in the fixture	d_f	[mm] 8,5	10,5

Table C18: Characteristic resistance F_{Rk} ¹⁾ for single anchor

Anchor size		FM-X5 8	FM-X5 10
Hollow brick - Blocco leggero $f_b \geq 7$ MPa	$24^\circ\text{C}^3/40^\circ\text{C}^4$	[kN] 0,9	0,9
Characteristic resistance F_{Rk}	$50^\circ\text{C}^3/80^\circ\text{C}^4$	[kN] 0,4	0,6
Partial safety factor	γ_{Mm} ²⁾	[-] 2,5	

¹⁾ Characteristic resistance F_{Rk} for tension, shear or combined tension and shear loading. The characteristic resistance is valid for single plastic anchor or for group of two or four plastic anchors with a spacing equal or larger than the minimum spacing s_{min} according to Table B3. The specific conditions for the design method have to be considered according to Annex B(1/2).

²⁾ IN absence of other national regulations

³⁾ Maximum long term temperature

⁴⁾ Maximum short term temperature

FM-X5	Annex C(7/12)
Performance Characteristic resistance in hollow clay brick - Blocco leggero (use category C)	

Base material hollow masonry: Hollow clay brick - Poroton

Table C19: Brick data

Description of brick		
Type of brick		Hollow clay brick - Poroton
Bulk density	$\rho \geq$	[kg/dm ³] 0,9
Standard		EN 771-1
Producer of brick		Fornaci di Manzano S.p.a 33044 Manzano (Ud) Italy
Format (measurement)		[mm] $\geq 250/300/190$
Minimum thickness of member	h_{min}	[mm] 250

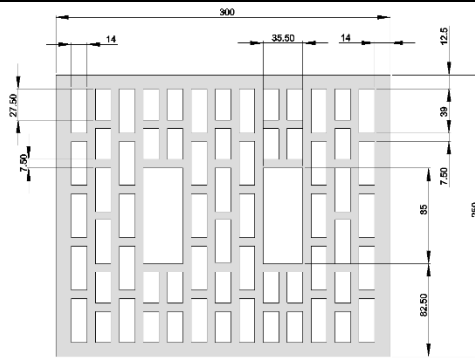

Table C20: Installation parameters

Anchor size		FM-X5 8	FM-X5 10
Drill hole diameter	d_0	[mm] 10	10
Cutting diameter of drill bit	$d_{cut} \leq$	[mm] 10,45	10,45
Depth of drill hole to deepest point	$h_1 \geq$	[mm] 80	80
Drill method		[-] Rotary drilling	
Overall plastic embedment depth	$h_{nom} =$	[mm] 70	70
Diameter of clearance hole in the fixture	d_f	[mm] 10,5	10,5

Table C21: Characteristic resistance $F_{Rk}^{1)}$ for single anchor

Anchor size		FM-X5 8	FM-X5 10
Hollow brick - Poroton $f_b \geq 22$ MPa	$24^\circ\text{C}^3)/40^\circ\text{C}^4)$	[kN] 1,5	2,0
Characteristic resistance F_{Rk}	$50^\circ\text{C}^3)/80^\circ\text{C}^4)$	[kN] 0,9	1,2
Partial safety factor	$\gamma_{Mm}^{2)}$	[-] 2,5	

¹⁾ Characteristic resistance F_{Rk} for tension, shear or combined tension and shear loading. The characteristic resistance is valid for single plastic anchor or for group of two or four plastic anchors with a spacing equal or larger than the minimum spacing s_{min} according to Table B3. The specific conditions for the design method have to be considered according to Annex B(1/2).

²⁾ IN absence of other national regulations

³⁾ Maximum long term temperature

⁴⁾ Maximum short term temperature

FM-X5	Annex C(8/12)
Performance Characteristic resistance in hollow clay brick - Poroton (use category C)	

Base material hollow masonry: Hollow clay brick Leopard Brique Perforée category 1-HD

Table C22: Brick data

Description of brick		
Type of brick		Hollow clay brick - Leopard BP category 1-HD
Bulk density	$\rho \geq$	[kg/m ³] 1,3
Standard		EN 771-1
Producer of brick		Pacema Groupe Wienerberge F- 67087 Strasbourg
Format (measurement)		[mm] $\geq 220/120/54$
Minimum thickness of member	h_{min}	[mm] 120

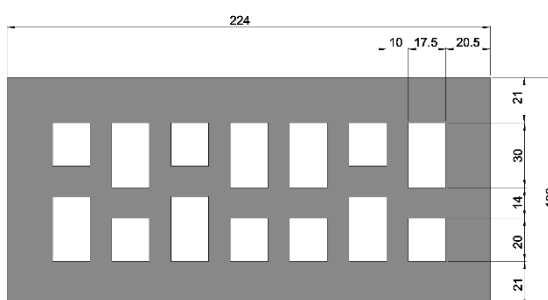

Table C23: Installation parameters

Anchor size		FM-X5 8	FM-X5 10
Drill hole diameter	d_0	[mm] 10	10
Cutting diameter of drill bit	$d_{cut} \leq$	[mm] 10,45	10,45
Depth of drill hole to deepest point	$h_1 \geq$	[mm] 80	80
Drill method		[-] Rotary drilling	
Overall plastic embedment depth	$h_{nom} =$	[mm] 70	70
Diameter of clearance hole in the fixture	d_f	[mm] 10,5	10,5

Table C24: Characteristic resistance F_{Rk} ¹⁾ for single anchor

Anchor size		FM-X5 8	FM-X5 10
Hollow clay brick - Leopard BP category 1HD $f_b \geq 30$ MPa	24°C ³⁾ /40°C ⁴⁾	[kN] 2,0	1,5
	50°C ³⁾ /80°C ⁴⁾	[kN] 0,9	0,9
Characteristic resistance F_{Rk}			
Partial safety factor	γ_{Mm} ²⁾	[-] 2,5	

¹⁾ Characteristic resistance F_{Rk} for tension, shear or combined tension and shear loading. The characteristic resistance is valid for single plastic anchor or for group of two or four plastic anchors with a spacing equal or larger than the minimum spacing s_{min} according to Table B3. The specific conditions for the design method have to be considered according to Annex B(1/2).

²⁾ IN absence of other national regulations

³⁾ Maximum long term temperature

⁴⁾ Maximum short term temperature

FM-X5	Annex C(9/12)
Performance Characteristic resistance in hollow clay brick - Brique Perforée category 1-HD (use category C)	

Base material hollow masonry: Blocks creux granulate en beton allege

Table C25: Brick data

Description of brick		
Type of brick		Hollow brick light weight concrete BC 203 n°26
Bulk density	$\rho \geq$	[kg/dm ³] 0,95
Standard		EN 771-3
Producer of brick		Carayon F-11590 Salleled d'Aude
Format (measurement)		[mm] $\geq 490/200/190$
Minimum thickness of member	h_{min}	[mm] 200

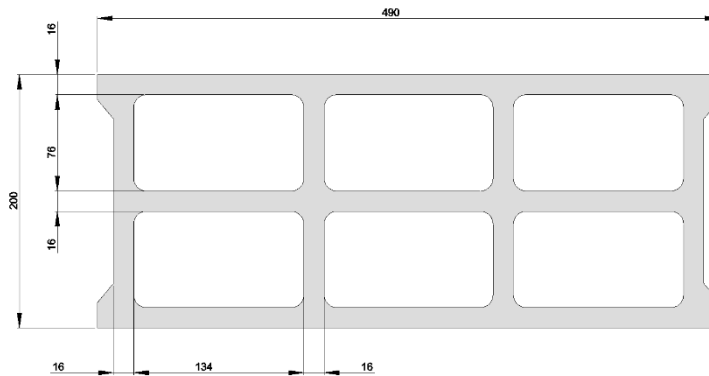

Table C26: Installation parameters

Anchor size		FM-X5 8	FM-X5 10
Drill hole diameter	d_0	[mm] 8	10
Cutting diameter of drill bit	$d_{cut} \leq$	[mm] 8,45	10,45
Depth of drill hole to deepest point	$h_1 \geq$	[mm] 80	
Drill method		[-] Rotary drilling	
Overall plastic embedment depth	$h_{nom} =$	[mm] 70	
Diameter of clearance hole in the fixture	d_f	[mm] 8,5	10,5

Table C27: Characteristic resistance $F_{Rk}^{1)}$ for single anchor

Anchor size		FM-X5 8	FM-X5 10
Hollow brick BC 203 n°26 $f_b \geq 4$ MPa	$24^\circ C^{3)}/40^\circ C^{4)}$	[kN] 0,75	0,6
Characteristic resistance F_{Rk}	$50^\circ C^{3)}/80^\circ C^{4)}$	[kN] 0,3	0,6
Partial safety factor	$\gamma_{Mm}^{2)}$	[-] 2,5	

¹⁾ Characteristic resistance F_{Rk} for tension, shear or combined tension and shear loading. The characteristic resistance is valid for single plastic anchor or for group of two or four plastic anchors with a spacing equal or larger than the minimum spacing s_{min} according to Table B3. The specific conditions for the design method have to be considered according to Annex B(1/2).

²⁾ In absence of other national regulations

³⁾ Maximum long term temperature

⁴⁾ Maximum short term temperature

FM-X5	Annex C(10/12)
Performance Characteristic resistance in hollow brick - Blocks creux granulate en beton allege (use category C)	

Base material: Autoclaved Aerated Concrete

Table C28: Brick data

Description of brick		
Type of brick		Autoclaved aerated concrete
Bulk density	$\rho \geq$	[kg/dm ³] 0,5
Standard		EN 771-4
Producer of brick		RDB Hebel S.p.A., Pontenure, Italia
Format (measurement)		[mm] $\geq 625/250/200$
Minimum thickness of member	h_{min}	[mm] 200

Table C29: Installation parameters

Anchor size		FM-X5 8	FM-X5 10
Drill hole diameter	d_0	[mm] 8	10
Cutting diameter of drill bit	$d_{cut} \leq$	[mm] 8,45	10,45
Depth of drill hole to deepest point	$h_1 \geq$	[mm] 80	
Drill method		[-] Hammer drilling	
Overall plastic embedment depth	$h_{nom} =$	[mm] 70	
Diameter of clearance hole in the fixture	d_f	[mm] 8,5	10,5

Table C30: Characteristic resistance F_{RK} ¹⁾ for single anchor

Anchor size		FM-X5 8	FM-X5 10
Autoclaved Aerated Concrete AAC	$f_b \geq$		
2,5 MPa	$24^\circ\text{C}^3)/40^\circ\text{C}^4)$	[kN] 0,6	0,6
Characteristic resistance F_{RK}	$50^\circ\text{C}^3)/80^\circ\text{C}^4)$	[kN] 0,6	0,5
Partial safety factor	$\gamma_{Mm}^2)$	[-] 2,0	

¹⁾ Characteristic resistance F_{RK} for tension, shear or combined tension and shear loading. The characteristic resistance is valid for single plastic anchor or for group of two or four plastic anchors with a spacing equal or larger than the minimum spacing s_{min} according to Table B3. The specific conditions for the design method have to be considered according to Annex B(1/2).

²⁾ In absence of other national regulations

³⁾ Maximum long term temperature

⁴⁾ Maximum short term temperature

FM-X5

Performance

Characteristic resistance in Autoclaved Aerated Concrete (use category D)

Annex C(11/12)

Table C31: Displacements under tension and shear loading in concrete

Concrete \geq C 16/20	Tension load			Shear load		
	F	δ_{N0}	$\delta_{N\infty}$	F	δ_{V0}	$\delta_{V\infty}$
	[kN]	[mm]	[mm]	[kN]	[mm]	[mm]
FM-X5 8	1,0	3,76	7,52	1,0	1,60	2,40
FM-X5 10	1,4	1,79	3,58	1,4	0,90	1,35

Table C32: Displacements under tension and shear loading in masonry

Base material	F	Displacement				F	Displacement			
		Tension load		Shear load			Tension load		Shear load	
		δ_{N0}	$\delta_{N\infty}$	δ_{V0}	$\delta_{V\infty}$		$\delta_{V\infty}$	$\delta_{V\infty}$	$\delta_{V\infty}$	$\delta_{V\infty}$
		[kN]	[mm]	[mm]	[mm]		[mm]	[mm]	[mm]	[mm]
		FM-X5 8				FM-X5 10				
Solid clay brick	0,86	1,74	3,48	0,71	1,10	1,00	2,40	4,80	0,83	1,25
Hollow clay brick - bimattone	0,43	1,81	3,62	0,86	1,29	0,43	1,70	3,40	0,86	1,29
Hollow clay brick – alveolater svizzero pesante	0,43	1,00	2,00	0,86	1,29	0,43	0,89	1,78	0,86	1,29
Hollow clay brick – alveolater 35	0,43	1,51	3,02	0,86	1,29	0,43	1,65	3,30	0,86	1,29
Hollow clay brick – blocco leggero	0,26	1,71	3,42	0,52	0,78	0,26	1,05	2,10	0,52	0,78
Hollow clay brick – poroton	0,43	1,80	3,60	0,86	1,29	0,57	1,61	3,22	0,86	1,29
Hollow clay brick – BP category 1 - HD	0,57	0,83	1,66	1,14	1,71	0,43	0,95	1,90	1,14	1,71
Hollow brick – light weight concrete – BC 203	0,21	2,32	4,64	1,00	1,50	0,17	1,59	3,18	0,34	0,51

Table C33: Displacements under tension and shear loading in Autoclaved Aerated Concrete

AAC 2	Tension load			Shear load		
	F	δ_{N0}	$\delta_{N\infty}$	F	δ_{V0}	$\delta_{V\infty}$
	[kN]	[mm]	[mm]	[kN]	[mm]	[mm]
FM-X5 8	0,21	0,94	1,88	0,18	1,00	1,50
FM-X5 10	0,21	1,88	3,76	0,27	1,50	2,25

FM-X5

Performance

Displacements in concrete and masonry

Annex C(12/12)